

M / OPR / 03



**Corporate Office:**

301, Punit Indl. Premises, Turbhe Naka, Navi Mumbai - 400 705.

**Tel.:** +91 22-2761 1176 / 77 / 78 / 79 / 80, 2761 8431

6139 3000 **Fax:** +91 22-2761 8421

**E-mail:** sales@contechindia.in / info@contechindia.in

**Website:** www.contechindia.com

**Factory:** Plot No. EL-221 TTC Indl. Area, MIDC (Electronic Zone),  
Mhape, Navi Mumbai-400 710.

**Tel.:** +91 22-6194 4000 **Fax:** +91 22-2761 8374

CIL-CB-5-2009/2K.JPG

CAC / CAD / CBI SERIES



OPERATING MANUAL

**CONTECH**<sup>®</sup>

# CONTENTS

1. BALANCE SKETCHES
2. WDS ASSEMBLY SKETCH
3. DENSITY KIT SKETCH
4. INTRODUCTION
5. INSTALLATION
6. BALANCE OPERATIONS & FUNCTIONS
  - 1) KEYBOARD DESCRIPTION.
  - 2) CHANGING WEIGHING UNITS
  - 3) CHANGING DATE/TIME/Sr.NO.
  - 4) PRINT OPTION
  - 5) RS232 INTERFACE
  - 6) STORAGE OF WEIGHTS
  - 7) POWER SAVING MODE.
  - 8) PEAK HOLD MODE.
  - 9) PIECE COUNTING MODE
  - 10) SET POINT FACILITY
  - 11) SIMPLE TARE MODE.
  - 12) DENSITY DETERMINATION OF SOLIDS.
  - 13) TEXTILE COUNTS
  - 14) GSM APPLICATION
  - 15) PERCENTAGE WEIGHING.
  - 16) AUTOCALIBRATION WITH STANDARD WEIGHTS.
  - 17) WEIGHT SLIP PRINTING.
7. SETUP FUNCTIONS

## WARRANTY

**CONTECH INSTRUMENTS LTD** warrants all its products against defects in material and workmanship for a period of one year, subject to terms and conditions stated below and as further modified by warranty Amendment, in each product instruction manual. The warranty card must be registered with us within 15 days of purchase.

1. Warranty period will commence from the date of shipment from **CONTECH**® to the original buyer.
2. All warranty repairs are normally done at our factory in Mumbai and our decision about faulty materials or workmanship will be final. The instrument should be sent in the original packing to our factory at the address given below. Postage /Airfreight charges both ways are to be borne by the customer.
3. If any of our product is opened by any one other than our engineers or our authorised representatives, this warranty will become null and void and **CONTECH**® will be relieved of all responsibilities as to the service and operation of the said product.
4. This warranty will not be applicable to :
  - a) Shipping damage or damages incurred while products are in transit.
  - b) Correction of operational problems arising out of environmental conditions beyond our control.
  - c) Maintenance necessitated by customer neglect, misuse, improper operation of the instrument or equipment.
  - d) Work necessitated by damages from war, accident, fire, flood, electrical failure, vandalism or any other causalities.
  - e) Repairs due to customers failure to perform any routine maintenance prescribed in the instruction manual.

(The routine inspection of calibration and other parameters should be done periodically by the user)

5. **CONTECH**® shall not be liable for any consequential damages nor labour loss or expense directly or indirectly arising from use of its products.,
6. Amendments, assumed corollaries or statements contrary to the terms of this warranty shall not be binding on us unless they are put in writing and approved by us.
7. Any disputes arising out of usage of this products will be subject to Mumbai jurisdiction.
8. For warranty service, contact your local dealer or contact us on the below address.

**Corporate Office:** 301, Punit Indl. Premises, Turbhe Naka, Navi Mumbai - 400 705.  
**Tel.:** +91 22-2761 1176 / 77 / 78 / 79 / 80, 2761 8431 , 6139 3000 **Fax:**+91 22-2761 8421  
**E-mail:** sales@contechindia.in / info@contechindia.in  
**Website:** www.contechindia.com

**Factory:** Plot No. EL-221 TTC Indl. Area, MIDC (Electronic Zone),  
Mhape, Navi Mumbai-400 710.  
**Tel.:** +91 22-6194 4000 **Fax:** +91 22-2761 8377

Product : \_\_\_\_\_ Purchase Ref.: \_\_\_\_\_  
Model No.: \_\_\_\_\_ Invoice No.: \_\_\_\_\_  
Sr. No.: \_\_\_\_\_ Date : \_\_\_\_\_

Dealer's Name & Address: \_\_\_\_\_  
\_\_\_\_\_  
\_\_\_\_\_

# BALANCE SKETCHES

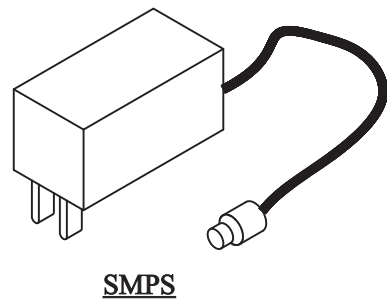
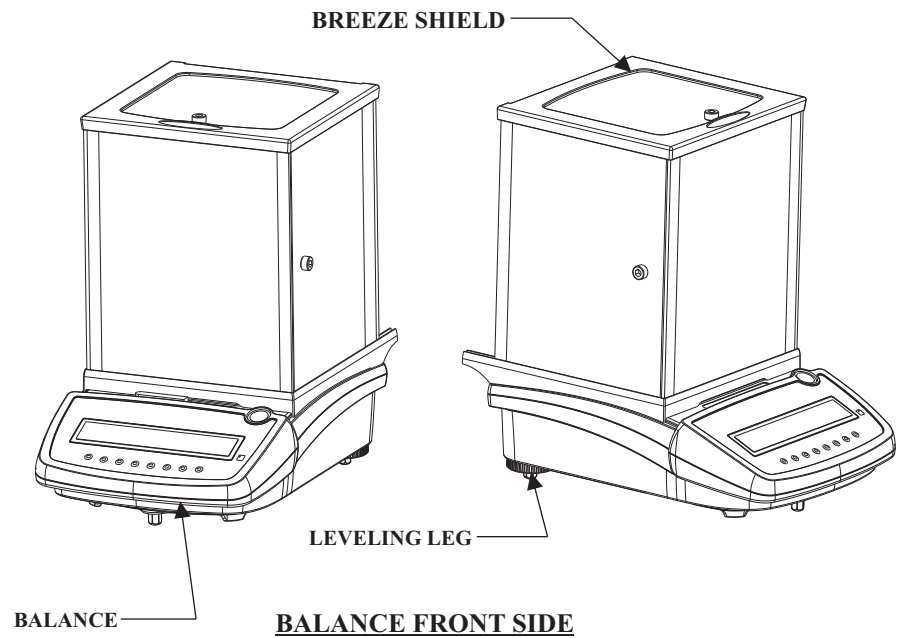

# BALANCE SKETCHES

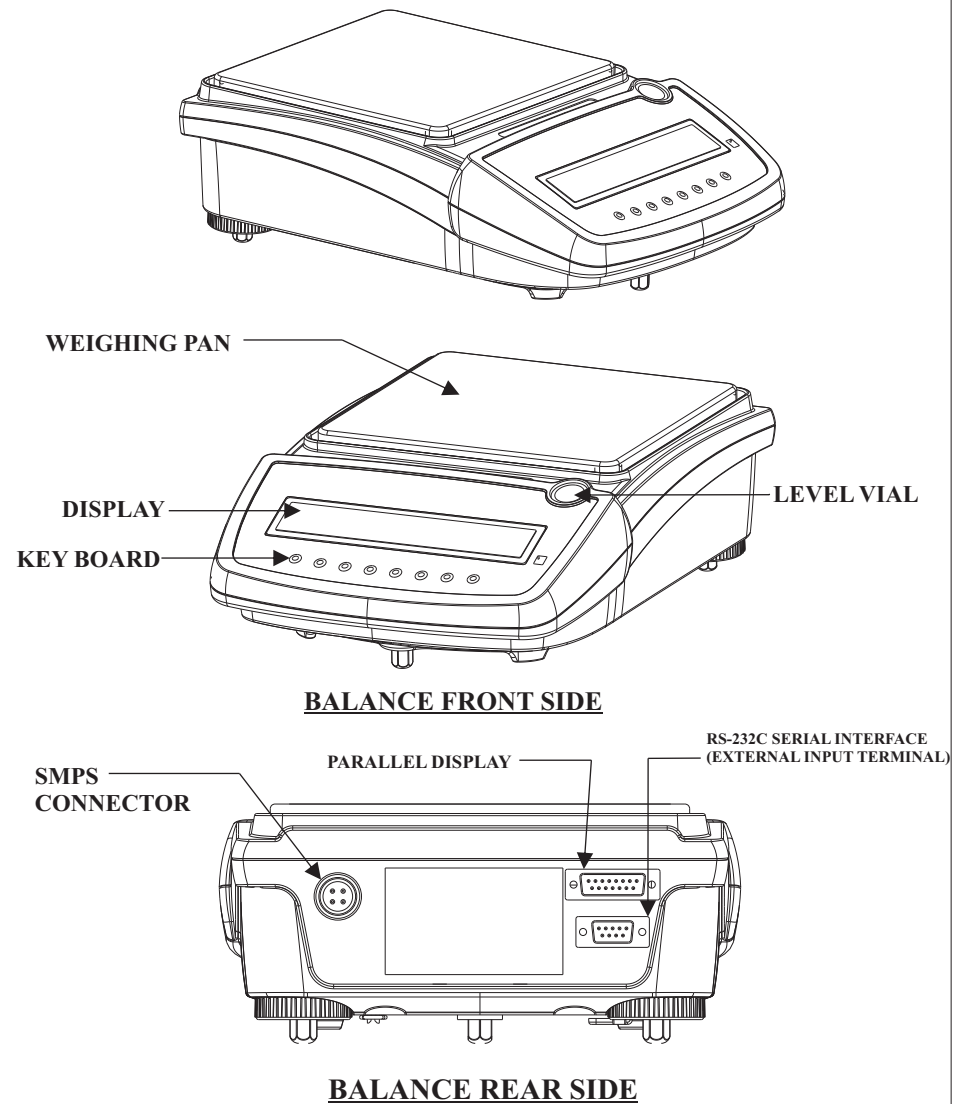

## WDS ASSEMBLY SKETCH

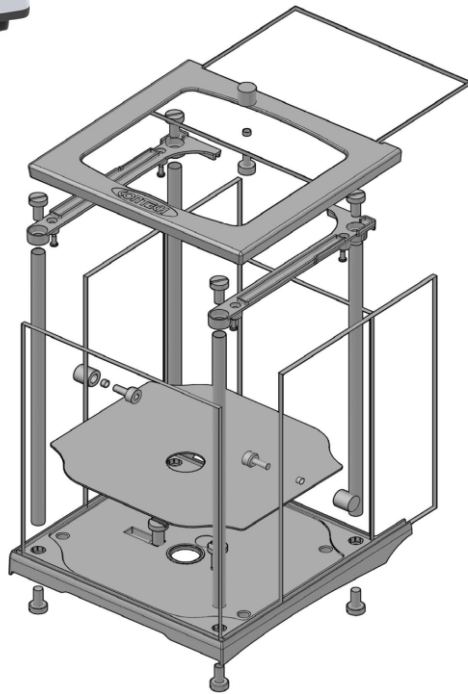

**BREEZE SHIELD EXTRACT VIEW**

## DENSITY KIT SKETCH

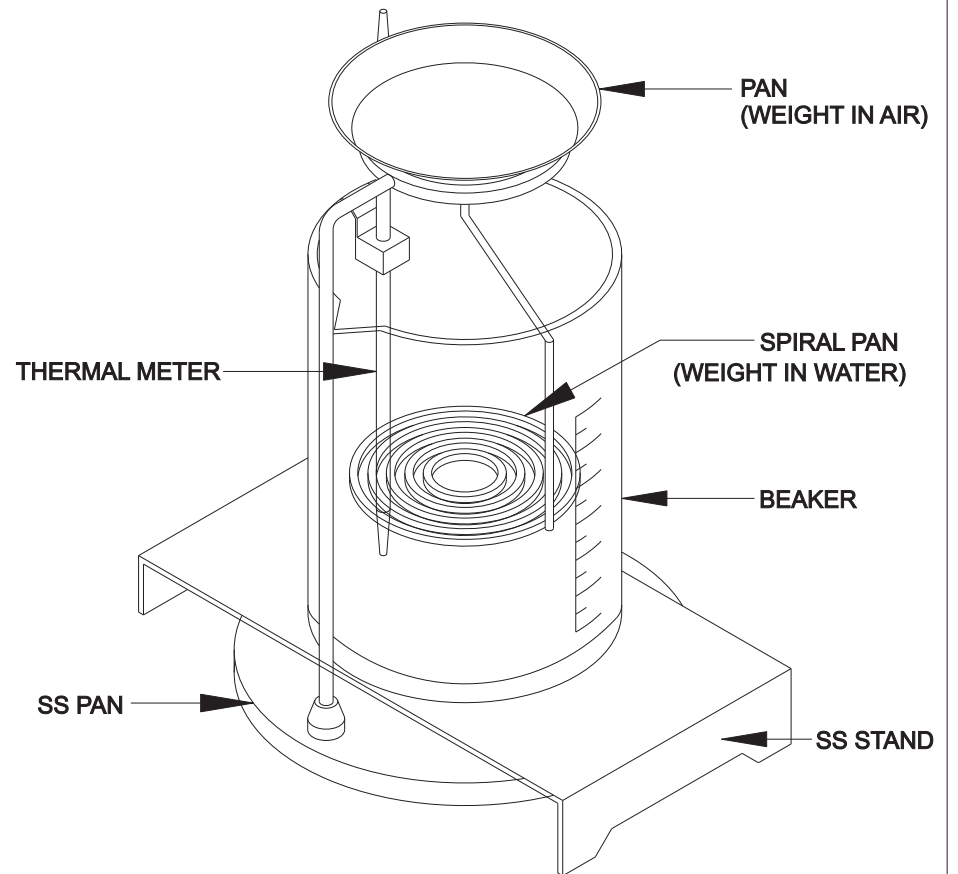

## INTRODUCTION

**Contech**<sup>®</sup> CAC/CAD/CBI Series weighing balances use Electro magnetic force compensation technique to measure precisely the weight of and object. The following features enable the user to suit these balances for variety of applications.



### Features:

- \* Multiple weighing units , Gram, Carat, Tola, , Pound , Grains, GSM, % weighing
- \* Piece counting facility, up to 25 different types.
- \* Storage of weights in memory and printing, up to 100 weights.
- \* Power saving mode.
- \* Bi-directional RS232 interface to interface with computers and printers.
- \* Selectable baud rate.
- \* Set point facility up to 2 limits.
- \* Auto Power off.
- \* Optional Peak Hold facility.
- \* Date and time facility.
- \* Multiple Print options with Sr. no., Date, Time and weight in Horizontal/Vertical mode.
- \* Automatic zero tracking.
- \* Density determination option.
- \* Optional Battery backup facility.
- \* GSM computation
- \* % weighing & Calibration.
- \* Weight slip printing option.

①

## INSTALLATION

### 1. Unpacking:

Unpack the balance. Save the packing container for future use.

### 2. Electrical requirements:

The balance requires very stable power. It works on 230V AC supply with PROPER EARTHING. The power outlet used for the balance should not be shared with any other devices which draws current in inconsistent manner like Airconditioner or refrigerator etc.

### 3. Environmental requirements:

For best results, the balance should be placed on a level surface which is free from drafts. It should not be exposed to direct sunlight or radiated heat. The balance should not be subjected to sudden ambient temperature changes. Table used for balance should be sturdy and should not transmit vibration from other equipments and free from the movement of people. No vibration producing equipment should be operated on the same platform balance

## START UP









### CAC/CAD/CBI Series

Power is supplied to the scale through a 4 pin Switch mode power supply supplied along with the balance. Connect the 4 pin SMPS to the balance to a 4 pin round male connector provided at the rear panel of the balance. Insert the connector and rotate the external cover to make the connection firm and proper. Connect the 4 pin SMPS to a proper AC mains outlet with proper Earthing.

②

## BALANCE OPERATIONS & FUNCTIONS

### 1) KEYBOARD DESCRIPTION :



-  - TO SETTING BALANCE DISPLAY ON OR OFF.
-  - USED FOR SETTING VARIOUS PARAMETERS
-  - CHANGING FUNCTIONS/PARAMETERS
-  - CHANGING FUNCTIONS/PARAMETERS.
-  - TO SELECT A PARAMETER/DATA
-  - AUTO CALIBRATION
-  - PRINTING INFORMATION THROUGH SERIAL PORT
-  - TARES THE BALANCE

### 2) CHANGING WEIGHING UNITS :

Press  OR  key,

Balance will show the next enabled weighing unit say  

And Carat will be selected.

Use  OR  keys to change between the enabled weighing units.

Note that all weighing functions except the basic weighing unit need to be enabled using SETUP functions. Refer section on SETUP for more details. Please note that some of the weighing functions in the balance may be illegal in some countries. They should be not be made available to the end user.

③

## BALANCE OPERATIONS & FUNCTIONS





### 3) FOR CHANGING DATE, TIME AND SERIAL NO:

Press  key, the balance will show SETUP

And immediately press  key, balance will show DATE

 12 (if the current date is 12)

where 12 is the current date. Press  Key

Use  to make it 0 or use  and  keys to change date and press  key to store the date.

Press  key to skip date entry.

The balance will display

 10 (if the current month is 10). Press  Key

where 10 is the current month. Use  to make it 0 or

use  and  keys to change month

and press  key to store the month.



Press  key to skip month entry.

The balance will display  06 (if the current year is 06)

Press  Key

Where 06 is the current year. Use  to make it 0 or

use  and  keys to change year and

press  key to store the year. Press  key to skip year entry.

④

## BALANCE OPERATIONS & FUNCTIONS

The balance will display

HH,mm,SS

where hh.mm.ss is the current time. Press  key to change the time

or press  key to quit time entry.

Press  key, the balance will show,

Hr 12 (if the current hour is 12)

where 12 is the hour. Use  to make it 0

or use  and  keys to change hour.

Press  key to save. Press  key to skip hour entry.

Balance will display

min 10 (if the current minute is 10)



where 10 is the minute. Use  to make it 0

or use  and  key to change minute.

Press  key to save. Press  key to skip minute entry.

Balance will display Sr 1234 (if the current Serial No. is 1234)

where 1234 is the current serial no. Use  to make the serial no.0 or

press  and  key to change serial number. Press  key to save.

## BALANCE OPERATIONS & FUNCTIONS

### 4. Print Option:

These balances can be attached to a serial printer for your printing needs. Print out can be programmed to suit most of the printing requirements.

Note that the printer should have a serial port and baud rate of the balance and printer should be same. 2 baud rates are available are. 2400 and 4800.

Press  key to print weight through the serial port.

Printing option and patterns are controlled by 4 SETUP parameters.

They are

#### a) Print : There are 4 options

- i) Single - Press  key to start printing weight and other details programmed as per (b), (c) and (d) below.
- ii) Stable - Printing is initiated when the weight kept on the pan becomes stable.
- iii) ALL - All the displayed weights are printed along with other details programmed as per (b), (c) below.
- iv) Store - To print weights stored in memory along with details programmed as per (b) & (c) below.

#### b) Pr.Fmt - Printer format. 6 printout formats are available.

- i) Pr F-1 - Only weight.
- ii) Pr F-2 - Serial no and weight.
- iii) Pr F-3 - Serial no, Date and weight.
- iv) Pr F-4 - Serial no., Time and weight.
- v) Pr F-5 - Serial no., Date, Time and weight.
- vi) Pr F-6 - Weight slip printing.

## BALANCE OPERATIONS & FUNCTIONS

### c) P-TYPE Print type (Horizontal or Vertical)

- i) **P-TYPE 1** – Horizontal  
Details will be printed horizontally.

Sr.No.	Date	Time	Weight
001	12.05.2002	13:25:00	23.54 g
002	12.05.2002	13:27:05	23.23 g

- ii) **P-TYPE 2** – Vertical  
Details will be printed vertically in a slip form.

For ex.

Sr.No. : 001  
Date : 12.05.2002  
Time : 13:25:00  
Weight : 24.45 g

Set the above parameters (a) to (c) to your requirements and effect printing. These parameters are available in SETUP functions.

7

## BALANCE OPERATIONS & FUNCTIONS

### 5) BI-DIRECTIONAL RS232-INTERFACE.

Bi-directional RS-232 interface is provided in these balances to communicate with devices like computer, printer etc. The interface is provided through a nine pin D-type connector provided at the rear side of the balance. Connections are as below.

Pin 2 – RXD – Receive Data  
Pin 3 – TXD – Transmit Data  
Pin 7 – Ground.

The Serial data transmitted and received are in standard ASCII mode (+/- 15V)-ASYNCHRONOUS, 8 BITS, NO PARITY, 1 STOP BIT.

Baud rate : 2400 OR 4800 SELECTABLE.

The data format for weight output is

<+/->WWWWWWW.WWb <bg/Ct> <CR><LF> ( 15 characters)

where WWWWWW.WW is the weight

b – blank space - 20 hex

CR- Carriage Return – 0D hex

LF – Line feed - 0A hex

for example, weight 85.12 g will be sent as

+	0	0	0	0	8	5	.	1	2	b	b	g	CR	LF
---	---	---	---	---	---	---	---	---	---	---	---	---	----	----

where b=black(20H), CR=carriage return (0dH)

LF=line feed (0a H)

The balance could be controlled by an external device like computer with the following commands.

Z - Tares the balance.

W# - Number of times, the weight data is to be transmitted through the serial port.

# can be any number from 1-9.

8







## BALANCE OPERATIONS & FUNCTIONS

### 6. STORAGE OF WEIGHTS IN MEMORY:

Upto 100 weights can be stored in memory and recalled if required. The balance also computes the total weight of all the weights in memory. To use this option, set ACCU function to ON in SETUP functions.

#### a) Clear weights in memory.





- Press  key, the balance will display -----
- Press  key immediately, balance will display **StorE**
- Press  key, balance will display **CLEAR**
- Press  key to clear the memory.

Weights in memory and total weight will be cleared.

#### b) Storing weight in memory.



Remove all the weights from the pan and make the weight zero by pressing  key.



Keep the sample on the pan and wait till the count becomes stable.

- Press  key, the balance will display -----
- Press  key immediately, balance will display **StorE**
- Press  key to store the weight in memory.
- Press  key to quit mode.

## BALANCE OPERATIONS & FUNCTIONS



### c) Recalling weights from memory.

- Press  key, the balance will display -----
- Press  key immediately, balance will display **StorE**
- Press  key, balance will display **n0 XX**  
(displays the sample no.)  
followed by **xxx.xx** (displays the weight)

- Press  and  keys to see all sample weight data.

After the balance displays the last weight data, it will display Total count and total number of samples.

If STAT function is enabled(See SETUP function) then the balance displays **AU xxx.xx** (Average weight)

- Press  key, balance displays **nX XXX.XX** (Maximum weight)
- Press  key, balance displays **n0 XXX.XX** (Minimum weight)
- Press  key, balance displays **Sd XXX.XX** (Standard deviation)
- Press  key, balance displays **CV XXX.XX** (Coefficient of Variation)

While viewing the above, Press  key to print all the results on a serial printer. Sample printout will appear as below.

## BALANCE OPERATIONS & FUNCTIONS

(Set PRINT option to “ ” in SETUP)

Sr.no.	DATE	TIME	WEIGHT
1.	12.10.04	13:30:20	12.56 g
2.	12.10.04	13:31:05	12.50 g
3.	12.10.04	13:31:25	13.40 g
4.	12.10.04	13:31:50	12.90 g
5.	12.10.04	13:32:05	12.03 g
6.	12.10.04	13:32:40	12.30 g
7.	12.10.04	13:32:55	12.56 g
8.	12.10.04	13:33:20	13.00 g
9.	12.10.04	13:33:55	11.95 g
10.	12.10.04	13:34:30	12.50 g

TOTAL : 125.70 g  
AVERAGE : 12.57g  
MAXIMUM : 13.40g  
MINIMUM : 11.95g  
STD. DEV. : 0.439  
C.V. : 3.50%

11

## BALANCE OPERATIONS & FUNCTIONS

### 7) POWER SAVING MODE

Power saving mode feature will further enhance the battery backup time by switching off the display whenever the weight displayed is zero. The balance will come out of Power saving mode when the displayed weight is not zero.



To enable this feature , refer SETUP mode.



### 8) PEAK HOLD MODE

Peak hold feature will enable the balance to hold the display to the maximum weight (Peak weight) displayed. When used in this mode, the balance will be continuously displaying the maximum or peak weight measured by the balance, even after the weight is removed from the pan. This feature is optional.

For using this mode, this function should be enabled in the SETUP mode.

For putting the balance into PEAK HOLD mode,

Press  and  keys simultaneously. The balance will show, **-PEA-**

Press  and  keys to exit peak hold mode, the balance will display

**nor**

12



## BALANCE OPERATIONS & FUNCTIONS



### 9) PIECE COUNTING MODE

Contech CAC/CAD/CBI series balances can be used for piece counting purposes also. Piece calibration of 25 items can be stored in memory. Accuracy of piece counting depends on the uniformity in weight of the items and the sample size used for piece calibration. Better the weight uniformity and more the sample size, better will be the accuracy.

Use SETUP function to select proper piece counting mode before using. There is an option to select 1, 10, 25 or none piece counting modes. See relevant section in SETUP functions for more details.



#### Selection of piece counting memory (item)

Press  or  keys till the balance displays

Press  or  keys to change between different piece counting memory

#### Piece Calibration

Select proper piece counting memory as mentioned above.

Make the Weight read zero by pressing the  key. Weight of any container/bags used should also be made zero by pressing  key.



Keep known number of pieces on the pan.

Press  key, the balance will display

PC xxxx

13

## BALANCE OPERATIONS & FUNCTIONS

Use  and  keys to change the number of pieces and make it equal

to the pieces kept on the pan.

Press  key. The balance will display

-----

Balance does piece calibration and displays the number of pieces on the pan, say

1 250

### 10) OPERATING IN SIMPLE TARE MODE:

In SIMPLE mode, balance can be operated in its simplest mode. In this mode,

Press  to make the weight zero.

All other functions will be disabled

14

## BALANCE OPERATIONS & FUNCTIONS



### 11) SET POINT FACILITY

This facility enables the user to set up to 2 weights for comparison with the current weights to activate different events. This feature is controlled by 3 SETUP functions.

1. FILL - Make it FL-on
2. SET-PT - Make it SET-1, SET-2 for 1 or 2 Set Points
3. F-TYPE swapping - Make it F-TYPE 1 or F-TYPE 2 for event depending on the requirement.

For setting weights, Press  key, and immediately followed by  key. the balance will show



and followed by  
XXXX.XX

Where XXXX.XX is the current set limit - 1. Use  and  keys to change the limit.

To discard changes, Press  &  keys simultaneously or Press  key to save.

The balance will show

FILL-2 (If fill option is on and limit is set to SET-2)

For some time and will display XXXX.XX  
Where XXXX.XX is the current set limit. Use  and  keys to change the limit.

To discard changes, Press  &  keys simultaneously or Press  key to save.

## BALANCE OPERATIONS & FUNCTIONS

### Set Point 1:

User can set a weight any where in the range of the balance. Depending on the weight on the pan, the following events occur. Buzzer will work only in case of models where buzzer is provided.

F-Type	Weight < Set Wt.	Weight = Set.	Weight > Set wt.
TYPE 1	Buzzer off	Buzzer off	Buzzer on
TYPE 2	Buzzer on	Buzzer off	Buzzer off

### Set Point 2:

User can set two weights any where in the range of the balance. Depending on the weight on the pan, the following events occur. Buzzer will work only in case of models where buzzer is provided.

F-Type	Weight within Set Limit	Weight = lower Upper limit	Weight is beyond the limits.
TYPE 1	Buzzer off	Buzzer off	Buzzer on
F-Type	Weight within Set Limit	Weight = lower Upper limit.	Weight is beyond the limits.
TYPE 2	Buzzer on	Buzzer off	Buzzer on

## BALANCE OPERATIONS & FUNCTIONS

### 12) DENSITY DETERMINATION OF SOLIDS

This is an optional feature, valid only if this facility is available in the product supplied. Balance calculates the density of solids based on Archimedes principle and displays it. The sample is weighed in both Air & Water and the balance calculates the density. There is a provision for entering the water temperature, so that necessary correction is applied for calculating density.

There are 2 types of density measurements.

#### 1. Normal mode

$$D = \frac{\text{Weight in Air}}{\text{(Weight in Air - Weight in Liquid)}} \times DL \times DW$$

D – Density

DL – liquid density (Programmable)

DW – Density of Water at measuring temperature.( If water is used)

For DW, Water temperature is programmable from 10 to 50 deg.C

DL is also programmable.

If DL is set to 1.0000 then water temperature correction will be applied.

If DL is set to a value other than 1.000 then water temperature correction will not be applied.

For example Weight in Air = 8.323g , Weight in water = 6.222g  
Water temperature = 25deg. Liquid density = 1.0000

Density = 3.9497 g/cc

## BALANCE OPERATIONS & FUNCTIONS

### 2. SETTING WATER TEMPERATURE

Measure the temperature of water with a good thermometer. Set the temperature value in the balance by the following.

Press  key, the balance will show **SET UP**



And immediately press  key

If date/time or limit functions are enabled balance goes through those entries.

Press  keys repeatedly till the balance displays

 **xx**

where xx is the currently stored temperature in memory.

Use  and  keys to change the temperature and

Press  key to save.

Note that maximum temperature cannot be more than 50 deg.



### 3. SETTING DENSITY OF LIQUID

Press  key, the balance will show **SET UP**

And immediately press  key

 **x.xxxx**

where x.xxxx is the currently stored density.

Use  and  keys to change the density and Press  key to save.

NOTE : IF THE DENSITY OF THE LIQUID IS PROGRAMMED VALUE OTHER THAN 1.0000 THEN WATER TEMPERATURE CORRECTION WILL NOT BE PERFORMED.  
IF DENSITY OF LIQUID IS 1.0000 THEN DENSITY WILL BE CORRECTED FOR WATER TEMPERATURE.

## BALANCE OPERATIONS & FUNCTIONS

### 4. DENSITY TESTING

Keep the sample on the upper pan of balance, wait for the weight display to become stable.

Press  key followed by  key. The balance will display  
- FirSt -

and the weight( Weight in Air) will be stored in memory.

Remove the sample from the upper pan and keep the same sample on the lower pan immersed in water. Wait for the weight display to become stable.

Press  key followed by  key. The balance will display  
- SEcond -

and the weight( Weight in water) will be stored in memory.

The balance now calculates the density and displays it.

Use  key. The balance will display weight in air  
d xx.xxx

Press  key again , The balance will display weight in water  
gA xxx.xx

Press  key again , The balance will display displaced volume of water  
gL xxx.xx

Press  key again , The balance will display density  
gd xxx.xx  
d xxx.xxx

For viewing the result any time during normal weighing,

Press  followed by  key.

Press  key while balance is displaying density to print the results.

For example  
WT. IN WATER : 122.56 g      WT. IN AIR : 115.35 g  
DISP. VOLUME: 7.21 g      DENSITY : 16.998 g/cc

19

## BALANCE OPERATIONS & FUNCTIONS

### 13) TEXTILE COUNTS

CAC/CAD/CBI Series balances directly calculate and display textile counts like cotton count, denier count, Tex Count, Worsted Count and sliver. This is an optional feature. The following details are valid, only if this feature is available in the balance. Enable this option in SETUP functions. (See Setup functions for more details). Length of the sample for the above counts are as follows.

Cotton	Cotton count	- 120 yd.
dENIER	Denier count	- 90 m.
TEX	Tex count	- 10 m
Worsted	Worsted count	- 10 yd.
	Sliver	- 10 yd.

Use  and  keys to change the unit ,

For eg.

Balance will display cotton count directly.

It is also possible to analyse the samples for consistency using statistical method.

For using statistical method , enable the **STAT** and **ACCU** options in **SETUP** functions. Also set the **PRINT** option to **Store**

For beginning the tests, clear the memory by the following.

Press  key, the balance will display -----

Press  key immediately, balance will display **Store**

Press  key, balance will display **CLEAR**

Press  key to clear the memory.

Store counts of all the samples to be tested one by one as per the following. Remove all the weights from the pan and make the weight zero by

pressing  key.

20

## BALANCE OPERATIONS & FUNCTIONS

Keep the sample on the pan and wait till the count becomes stable.

Press  key, the balance will display -----

Press  key immediately, balance will display **StorE**



Press  key to store the count in memory.

Store all the counts in memory with above procedure. For viewing sample data and other statistical details, do the following.

Press  key, the balance will display -----

Press  key immediately, balance will display **StorE**

Press  key, balance will display **no XX** ( displays the sampleno.)  
followed by **XXX.XX** ( displays the count)

Press  and  keys to see all sample data. After the balance displays the last data, it will display Total count and total number of samples. Then it displays

Press  key, balance displays **AU xxx.xx** ( Average count)  
**xxx.xx** ( Maximum count)

Press  key, balance displays **MX**  
**xxx.xx** ( Minimum count)

Press  key, balance displays **SD**  
**xxx.xx** ( Standard deviation)

Press  key, balance displays **CV**  
**xxx.xx** ( Coefficient of Variation)

While viewing the above, Press  key to print all the results on a serial printer.  
Sample printout will appear as below.

Sr.no.	COUNT	
1.	12.56 CC	
2.	12.50 CC	
3.	13.40 CC	
4.	12.90 CC	TOTAL : 125.70
5.	12.03 CC	AVERAGE : 12.57
6.	12.30 CC	MAXIMUM : 11.95
7.	12.56 CC	MINIMUM : 13.40
8.	13.00 CC	STD. DEV. : 0.439
9.	11.95 CC	C.V. : 3.50%
10.	12.50 CC	

## BALANCE OPERATIONS & FUNCTIONS



### 14) GSM APPLICATION

CAC/CAD/CBI series balances can be used to determine GSM(Grams per Sq.meter).

The following description is valid only if this feature is available in the balance and enabled. The balance displays directly the GSM value of fabric or paper of specified area. Enable GSM feature in the SETUP functions. 5 pre-programmed area (rectangular or round) are available in the balance. **Standard areas are:**

1. 5 X 5 cm
2. 10 X 10 cm
3. 20 X 20 cm
4. 25 X 20 cm
5. 25 X 25 cm

#### Select GSM mode:

Use  and  keys to change till the balance displays **-g5-**

Balance now enters GSM mode.



For changing the area, Press  key, the balance displays -----

Press  key immediately, balance displays **Ar** **XX.XX**

Repeat the procedure till desired area is selected.

### 15) PERCENTAGE WEIGHING

Selection of percentage weighing mode.

Press  or  keys till the balance displays **PERC**

PERCENTAGE weighing function is used to determine % weight gain/loss. Any weight within the capacity can be set to be 100%. The balance displays the weight gain/loss in % of the original weight. This function must be enabled using SETUP function. This feature is very useful in determining % loss/gain in moisture in food/tea/pharmaceutical industries.

For eg. Keep a 25g weight on the pan.

Press  key, the balance calibrates 25g as 100% and displays **100.0**

After this any change in weight on the pan will be indicated as % of original weight(25g), till the balance is calibrated for 100% with another weight.

## BALANCE OPERATIONS & FUNCTIONS

### 16) AUTOCALIBRATION WITH STANDARD WEIGHTS

CAC/CAD/CBI Series balances can be calibrated for weight with standard mass. Balances can be calibrated with 100g, 200g, 500g and 1000g weights depending on the models.

Models upto 1kg can be calibrated with 100g,200g,500g, 1000g weights  
Models upto 600g can be calibrated with 100g,200g,500g weights  
Models upto 350g can be calibrated with 100g,200g weights  
Models upto 300g can be calibrated with 100g,200g weights  
Models upto 220g can be calibrated with 100g,200g weights  
Models upto 125g can be calibrated with 50g, 100g weight.

Enable calibration function in SETUP mode before attempting to calibrate the balance.(Refer SETUP functions for more details). This function should not be made available to the end user, if there is any restriction in usage of this function.

### CALIBRATING THE BALANCE



Use only good calibrated weights for performing auto calibration.  
Press  key to make the weight read zero.

Keep the standard mass on the pan and wait for it to become stable.

Press  key.

Balance will display -----  
And will subsequently display **CAL done**

For setting balance calibration back to default factory setting,

Press  key and immediately press  key.



Balance will display **-rEFrESH-**  
Balance weight calibration will now be restored to factory settings.

## BALANCE OPERATIONS & FUNCTIONS



### 17) WEIGHT SLIP PRINTING

In this mode, the balance prints weight with date, time and details of the articles like gold/silver/diamond.

To use this mode, set PRINT option to **PrF-6** in SETUP mode.

To select the item, Press  key followed immediately by  key,  
the balance will display **-gOLd-**

to select item gold or press  key followed immediately by  key,  
the balance will display **-SiL-**

to select item Silver or press  key followed immediately by  key,  
the balance will display **-diA-**  
to select diamond.

Set Date and time as given earlier in the manual (Refer to section on Changing date, time, Sr.no.)

Press  key to print the slip. A sample printout will appear as below.

XYZ Co.  
ADDRESS  
ADDRESS

-----  
Sr.No : 23  
Date : 11.09.2006  
Item : GOLD  
Weight : 11.250g

-----  
Charges : Rs. \_\_\_\_/-

Thank You. Visit again



## BALANCE OPERATIONS & FUNCTIONS

### ENTERING SETUP MODE

Switch Off the balance.

Switch on the machine keeping the  key pressed. Do not release this key until the balance displays

SET UP

And subsequently displays

FACT

For changing between the menu mentioned above

Press , or  or  keys

For selecting the menu, Press  key.

For changing the parameters, Press  or  key and Press  to save.

Press  to quit setup mode.

**\*\*\* PLEASE NOTE THAT SOME FUNCTIONS IN THE BALANCE MAY NOT BE LEGAL IN SOME PLACES. THESE FUNCTIONS SHOULD NOT BE MADE AVAILABLE TO THE END USER. THESE UNITS CAN BE SWITCHED OFF BY PROGRAMMING.\*\*\***

## SETUP FUNCTIONS

SETUP functions control the basic operation of the balance. There are 29 parameters, which can be set by the user to suit the requirements. The following are the parameters.

MENU NAME	FUNCTION	OPTIONS	DESCRIPTION
1. FACT	Factory setting		To select factory set parameters.
2. PARTS	Piece counting modes	PART-1 PART-10 PART-25 NO PART	To select single piece counting memory. To select 10 piece counting memory. To select 25 piece counting memory To disable piece counting.
3. BAUD	Baud rate setting	bd2400 bd4800	To select 2400 baud rate To select 4800 baud rate
4. Print	Print modes set.	Single Stb ALL StorE	Send stable weight through serial port when  key is pressed. Send weight through serial port Every time balance reading becomes stable. Send weight continuously. Send stored weights through serial port.
5. AUTO-0	Auto zero setting (Ability of the balance to remain at zero, when there is no weight on the pan.	A-0 A-1 A-2 A-3	Autozero disabled. Autozero to half accuracy of balance. Autozero to full accuracy of balance. Autozero to twice the accuracy of balance.
6. ACCU	Weight storage mode	Ac-no Ac-YES	Weight storage disabled Weight storage enabled
7. FILL	Fill mode option	FL-off FL-on	Fill mode disabled Fill mode enabled

## SETUP FUNCTIONS

- |                   |                   |                  |                            |
|-------------------|-------------------|------------------|----------------------------|
| 8. <b>CAL</b>     | Auto calibration  | <b>CAL-off</b>   | Autocalibration disabled   |
|                   |                   | <b>CAL-on</b>    | Autocalibration enabled    |
| 9. <b>Pound</b>   | Pound weighing    | <b>Pnd-off</b>   | Pound weighing disabled    |
|                   |                   | <b>Pnd-on</b>    | Pound weighing enabled     |
| 10. <b>Carat</b>  | Carat weighing    | <b>Cr-t-off</b>  | Carat weighing disabled    |
|                   |                   | <b>Cr-t-on</b>   | Carat weighing enabled     |
| 11. <b>tola</b>   | tola weighing     | <b>tol-off</b>   | Tola weighing disabled     |
|                   |                   | <b>tol-on</b>    | Tola weighing enabled      |
| 12. <b>Grain</b>  | Grain weighing    | <b>Grain-off</b> | Grain mode disabled        |
|                   |                   | <b>Grain-on</b>  | Grain mode enabled         |
| 13. <b>PERC</b>   | % weighing        | <b>PERC-off</b>  | % mode disabled            |
|                   |                   | <b>PERC-on</b>   | % mode enabled             |
| 14. <b>GSM</b>    | GSM               | <b>GSM-off</b>   | GSM mode disabled          |
|                   |                   | <b>GSM-on</b>    | GSM mode enabled           |
| 15. <b>PSN</b>    | Power saving mode | <b>PSN-off</b>   | Power saving mode disabled |
|                   |                   | <b>PSN-on</b>    | Power saving mode enabled  |
| 16. <b>P-Hold</b> | Peak hold mode    | <b>PHF-off</b>   | Peak hold mode disabled    |
|                   |                   | <b>PHF-on</b>    | Peak hold mode enabled     |

## SETUP FUNCTIONS

- |                   |                         |                  |  |
|-------------------|-------------------------|------------------|--|
| 17. <b>3d-SET</b> | Third decimal mode      | <b>P3d-off</b>   | Third decimal mode disabled            |
|                   |                         | <b>P3d-on</b>    | Third decimal mode enabled             |
| 18. <b>title</b>  | Title printing          | <b>tle-off</b>   | Title printing disabled                |
|                   |                         | <b>tle-on</b>    | Title printing enabled                 |
| 19. <b>P-TYPE</b> | Select printing mode    | <b>P-TYPE 1</b>  | Horizontal Printing mode               |
|                   |                         | <b>P-TYPE 2</b>  | Vertical Printing mode                 |
| 20. <b>Pr.Fmt</b> | Select print formats    | <b>Pr,F 1</b>    | Only weight                            |
|                   |                         | <b>Pr,F 2</b>    | Sr.no. Weight                          |
|                   |                         | <b>Pr,F 3</b>    | Sr.no., Date, Weight                   |
|                   |                         | <b>Pr,F 4</b>    | Sr.no., Time, Weight                   |
|                   |                         | <b>Pr,F 5</b>    | Sr.no., Date, Time, Weight             |
|                   |                         | <b>Pr,F 6</b>    | Weight slip Printing                   |
| 21. <b>SET-PT</b> | Select set point mode   | <b>SET-1</b>     | Single set point                       |
|                   |                         | <b>SET-2</b>     | 2 set points.                          |
| 22. <b>F-TYPE</b> | Select set point type   | <b>F-TYPE 1</b>  | +ve Logic outputs for fill application |
|                   |                         | <b>F-TYPE 2</b>  | -ve Logic outputs for fill application |
| 23. <b>dENS</b>   | Density mode            | <b>dENS-off</b>  | Density mode off                       |
|                   |                         | <b>dENS-on</b>   | Density mode on.                       |
| 24. <b>Count</b>  | Textile count mode.     | <b>Count-off</b> | Textile Count mode off                 |
|                   |                         | <b>Count-on</b>  | Textile Count mode on.                 |
| 25. <b>STAT</b>   | Statistical report mode | <b>STAT-off</b>  | Statistical report off                 |
|                   |                         | <b>STAT-on</b>   | Statistical report on.                 |

## SETUP FUNCTIONS

### Factory default parameters.

PARt5	PARt-1	To select single piece counting memory
BAUD	bd4800	To select 4800 baud rate
Print	Single	Send stable weight through serial port
Auto-0	A-1	Autozero to half accuracy of balance
ACCU	Ac-no	Weight storage disabled
FILL	FL-off	Fill mode disabled
CAL	CAL-off	Autocalibration disabled
Pound	Pnd-off	Pound weighing disabled
CARat	Crt-off	Carat weighing disabled
tola	tol-off	Tola weighing disabled
grain	Grain-off	Grain mode disabled
%	PER-off	% mode disabled
GSM	GSM-off	GSM disabled
PSn	PSn-off	Power saving mode disabled
P-Hold	PHF-off	Peak hold mode disabled
3d-SET	P3d-off	Third decimal mode disabled
tiLE	tiLE-off	Title printing disabled
P-tYPE	P-tYPE 1	Horizontal Printing mode
P-rFt	P-rF 1	Only weight
SETUP	SET-1	Single set point
F-tYPE	F-tYPE 1	+ve Logic outputs for fill application
Count	Count-off	Textile counts off
dEn-tYPE	dEnS-off	Density type 1
Stat	Stat-off	Statistical reports off